

DOCUMENT RESUME

ED 471 875

EA 032 203

AUTHOR Wirt, John; Livingston, Andrea
TITLE The Condition of Education 2002 in Brief.
INSTITUTION National Center for Education Statistics (ED), Washington, DC.
REPORT NO NCES-2002-011
PUB DATE 2002-08-00
NOTE 29p.
AVAILABLE FROM ED Pubs, P.O. Box 1398, Jessup, MD 20794-1398. Tel: 877-433-7827 (Toll Free); Web site: <http://www.nces.ed.gov>. For full text: <http://www.nces.ed.gov/pubs2002/2002011.pdf>.
PUB TYPE Numerical/Quantitative Data (110) -- Reports - Descriptive (141)
EDRS PRICE EDRS Price MF01/PC02 Plus Postage.
DESCRIPTORS Early Childhood Education; Educational Attainment; Educational Change; *Educational Indicators; *Educational Practices; Educational Quality; *Educational Trends; Elementary Secondary Education; Enrollment; Foreign Countries; National Surveys; Outcomes of Education; Postsecondary Education; Poverty; Program Evaluation; *School Statistics; Student Characteristics; Tables (Data); Teacher Characteristics
IDENTIFIERS *Condition of Education (NCES)

ABSTRACT

This report is an indicator summary, synthesizing the state of education, monitoring important developments, and showing trends in major aspects of education. It contains a sampling of charts of the 44 indicators in "The Condition of Education, 2002." Graphs depict past and projected trends in early childhood education programs; past and projected elementary and secondary school enrollments; poverty among school-aged children; past and projected undergraduate enrollments; mathematics performance of students in grades 4, 8, and 12; poverty and student achievement; trends in the achievement gap in reading between white and black students; international comparisons of reading literacy; 12th-graders' effort and interest in school; status dropout rates, by race/ethnicity; immediate transition to college; high school academic preparation and postsecondary progress; trends in science and mathematics course-taking; inclusion of students with disabilities in regular classrooms; parental choice of schools; academic background of college graduates who enter and leave teaching; perceived impact of work on postsecondary learning; student participation in distance education; status of women and minority faculty; public effort to fund education; change in public-school revenue sources; and international comparisons of expenditures for education. (RT)

Reproductions supplied by EDRS are the best that can be made
from the original document.

the condition of education 2002 in Brief

U.S. DEPARTMENT OF EDUCATION
Office of Educational Research and Improvement
EDUCATIONAL RESOURCES INFORMATION
CENTER (ERIC)

- This document has been reproduced as received from the person or organization originating it.
- Minor changes have been made to improve reproduction quality.
- Points of view or opinions stated in this document do not necessarily represent official OERI position or policy.

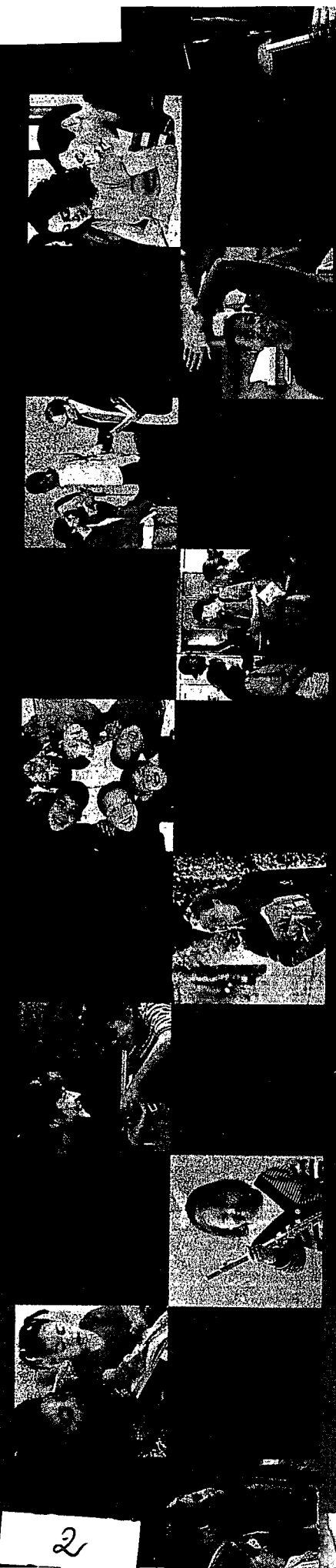

NATIONAL CENTER FOR EDUCATION STATISTICS

U.S. Department of Education ■ Office of Educational Research and Improvement

NCES 2002-011

BEST COPY AVAILABLE

the condition of education 2002 in Brief



3

NCES NATIONAL CENTER FOR EDUCATION STATISTICS
U.S. Department of Education ■ Office of Educational Research and Improvement

NCES 2002-011

U.S. Department of Education

Rod Paige
Secretary

Office of Educational Research and Improvement

Grover J. Whitehurst
Assistant Secretary

National Center for Education Statistics

Gary W. Phillips
Deputy Commissioner

The National Center for Education Statistics (NCES) is the primary federal entity for collecting, analyzing, and reporting data related to education in the United States and other nations. It fulfills a congressional mandate to collect, collate, analyze, and report full and complete statistics on the condition of education in the United States; conduct and publish reports and specialized analyses of the meaning and significance of such statistics; assist state and local education agencies in improving their statistical systems; and review and report on education activities in other countries.

NCES activities are designed to address high priority education data needs; provide consistent, reliable, complete, and accurate indicators of education status and trends; and report timely, useful, and high quality data to the U.S. Department of Education, the Congress, the states, other education policymakers, practitioners, data users, and the general public.

We strive to make our products available in a variety of formats and in language that is appropriate to a variety of audiences. You, as our customer, are the best judge of our success in communicating information effectively. If you have any comments or suggestions about this or any other U.S. Department of Education, National Center for Education Statistics product or report, we would like to hear from you. Please direct your comments to:

National Center for Education Statistics
Office of Educational Research and Improvement
U.S. Department of Education
1990 K Street, NW
Washington, DC 20006-5651

August 2002

The NCES World Wide Web Home Page is: <http://nces.ed.gov>

The NCES World Wide Web Electronic Catalog is: <http://nces.ed.gov/pubsearch>

Suggested Citation:

U.S. Department of Education, National Center for Education Statistics, *The Condition of Education 2002 in Brief*, NCES 2002-011, by John Wirt and Andrea Livingston. Washington, DC: 2002.

For additional information, contact John Wirt, National Center for Education Statistics (phone: 202-502-7478; e-mail: john.wirt@ed.gov).

To order this publication or the complete volume, write:

U.S. Department of Education, ED Pubs, P.O. Box 1398, Jessup, MD 20794-1398
or call toll free 1-877-4ED-PUBS.

The complete volume also appears on the NCES Web site (<http://nces.ed.gov/programs/coe>).

What's Inside

This publication contains a sample of the 44 indicators in **The Condition of Education 2002**. To order the entire printed edition of **The Condition**, complete and return the enclosed card or call ED PUBS (1-877-4ED-PUBS).

The indicators in this publication are numbered sequentially, rather than according to their numbers in the complete edition. The Contents page offers a cross reference between the two publications.

Since 1870, the federal government has gathered data about students, teachers, schools, and education funding. As mandated by Congress, the U.S. Department of Education's National Center for Education Statistics (NCES) annually publishes a statistical report on the status and progress of education in the United States. **The Condition of Education** includes data and analysis on a wide variety of issues. The indicators in the 2002 edition are in six sections:

- Participation in Education
- Learner Outcomes
- Student Effort and Educational Progress
- Contexts of Elementary and Secondary Education
- Contexts of Postsecondary Education
- Societal Support for Learning

The indicators in **The Condition of Education** use data from government and private sources. The complete publication includes two special analyses: one on private elementary and secondary schools and the other on nontraditional undergraduates. It also contains additional tables and notes related to each indicator.

The Condition of Education in Brief and the complete edition are available on the NCES Web site (<http://nces.ed.gov>).

Contents

<hr/>	
Participation in Education	Indicator 1 Enrollment in Early Childhood Education Programs (<i>Indicator 1</i>) 2
	Indicator 2 Past and Projected Elementary and Secondary School Enrollments (<i>Indicator 2</i>) 3
	Indicator 3 Poverty Among School-Aged Children (<i>Indicator 4</i>) 4
	Indicator 4 Past and Projected Undergraduate Enrollments (<i>Indicator 5</i>) 5
<hr/>	
Learner Outcomes	Indicator 5 Mathematics Performance of Students in Grades 4, 8, and 12 (<i>Indicator 10</i>) 6
	Indicator 6 Poverty and Student Achievement (<i>Indicator 11</i>) 7
	Indicator 7 Trends in the Achievement Gap in Reading Between White and Black Students (<i>Indicator 8</i>) 8
	Indicator 8 International Comparisons of Reading Literacy (<i>Indicator 9</i>) 9
<hr/>	
Student Effort and Educational Progress	Indicator 9 12 th -Graders' Effort and Interest in School (<i>Indicator 18</i>) 10
	Indicator 10 Status Dropout Rates, by Race/Ethnicity (<i>Indicator 19</i>) 11
	Indicator 11 Immediate Transition to College (<i>Indicator 20</i>) 12
	Indicator 12 High School Academic Preparation and Postsecondary Progress (<i>Indicator 23</i>) 13
<hr/>	
Contexts of Elementary and Secondary Education	Indicator 13 Trends in Science and Mathematics Course-taking (<i>Indicator 26</i>) 14
	Indicator 14 Inclusion of Students With Disabilities in Regular Classrooms (<i>Indicator 28</i>) 15
	Indicator 15 Parental Choice of Schools (<i>Indicator 29</i>) 16
	Indicator 16 Academic Background of College Graduates Who Enter and Leave Teaching (<i>Indicator 31</i>) 17
<hr/>	
Contexts of Postsecondary Education	Indicator 17 Perceived Impact of Work on Postsecondary Learning (<i>Indicator 37</i>) 18
	Indicator 18 Student Participation in Distance Education (<i>Indicator 38</i>) 19
	Indicator 19 Status of Women and Minority Faculty (<i>Indicator 39</i>) 20
<hr/>	
Societal Support for Learning	Indicator 20 Public Effort to Fund Education (<i>Indicator 42</i>) 21
	Indicator 21 Change in Public School Revenue Sources (<i>Indicator 43</i>) 22
	Indicator 22 International Comparisons of Expenditures for Education (<i>Indicator 41</i>) 23

Enrollment in Early Childhood Education Programs

Enrollment rates for 3- to 5-year-olds in early childhood education programs were higher in 2001 than 1991. Children from poor families enroll at lower rates than those from nonpoor families.

Between 1991 and 2001, the percentage of children ages 3–5 who had not yet entered kindergarten and who attended center-based early childhood care and education programs—such as Head Start, nursery school, and prekindergarten—rose from 53 to 56 percent. Some groups of children enroll in these programs at higher rates than others. Children living in families that are below poverty are less likely to participate in early childhood education programs than children in families living at or above poverty. The difference in rates of participation between children from poor and nonpoor families was 12 percentage points in 2001 (47 versus 59 percent). No statistically significant change in this difference has occurred since 1991.

ENROLLMENT IN PREPRIMARY EDUCATION: Percentage of children ages 3–5 who were enrolled in center-based early childhood care and education programs, by poverty status: Selected years 1991–2001

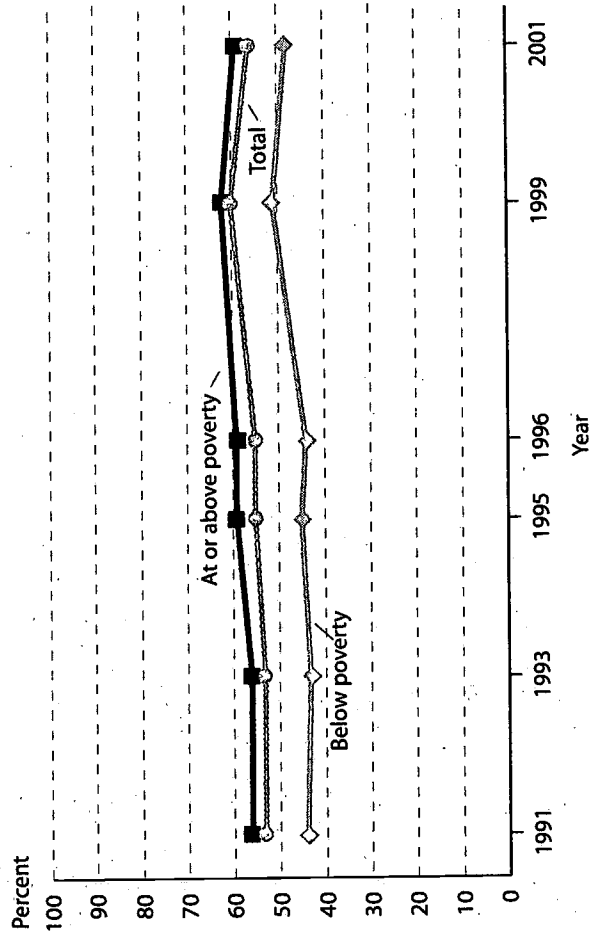

NOTE: Estimates are based on children who had not entered kindergarten. Center-based programs include day care centers, Head Start, preschool, nursery school, prekindergarten, and other early childhood programs.

SOURCE: U.S. Department of Education, NCES. National Household Education Surveys Program (NHES), "Parent Interview" survey, various years.

Public elementary and secondary enrollment is projected to reach 47.4 million in 2002, and to increase through 2005, before decreasing slowly.

As a result of the “baby boom echo” and rising immigration, public elementary and secondary school enrollment increased in the latter part of the 1980s and in the 1990s, reaching an estimated 47.2 million in 2001. Through the first half of this decade, public enrollment for grades K–12 is projected to continue increasing to an all-time high of 47.5 million in 2005, and then to begin declining slightly. Between 2001 and 2011, public enrollment in grades K–8 is projected to decrease slowly through 2008 and then to increase slowly, whereas public enrollment in grades 9–12 is projected to increase through 2006 and then to decrease slowly.

Past and Projected Elementary and Secondary School Enrollments

SCHOOL ENROLLMENT: Public elementary and secondary school enrollment in grades K–12 (in thousands), by grade level, with projections: Fall 1965–2011

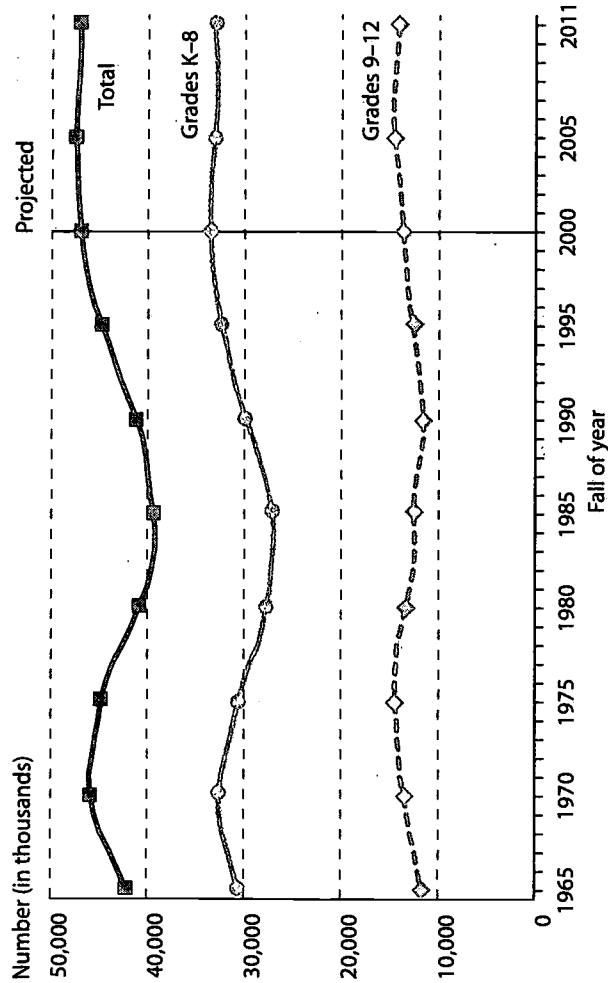

NOTE: Includes most kindergarten and some nursery school enrollment.

SOURCE: U.S. Department of Education, NCES, Common Core of Data (CCD), various years, and (2001) *Projections of Education Statistics to 2011* (NCES 2001–083).

Poverty Among School-Aged Children

Although school-aged children who are poor live in all areas of the United States, they are more heavily concentrated in some areas than others.

Poor children can be found across the United States, but the extent to which they are concentrated in various areas differs appreciably. In 1997, the school-age poverty rate in public school districts ranged from 29 percent on average in U.S. central cities within large metropolitan areas to an average of 13 percent in suburbs within large and small metropolitan areas. Whereas the suburbs and "exurbs" (rural areas within metropolitan areas) in the Northeast and Midwest had rates that were about half the national rate, in the South and West, rates were similar to the national rate. A third of all school-aged children in U.S. central cities within large metropolitan areas in the Northeast lived in poverty in 1997.

ELEMENTARY AND SECONDARY EDUCATION: Percentage of related children ages 5-17 in poverty, by region and urbanicity: 1997

Urbanicity	Total	Region			
		Northeast	Midwest	South	West
Total	18.3	17.7	14.5	20.2	19.8
Central city within large MSA	28.5	34.3	28.6	24.7	27.9
Central city within small MSA	22.0	29.5	18.9	22.3	20.2
Suburb within large MSA	12.1	10.2	7.3	13.5	15.6
Suburb within small MSA	14.9	9.7	9.4	18.6	17.4
Large town	19.3	18.7	16.0	23.2	18.6
Small town	20.3	16.0	14.5	25.7	19.7
Rural not within MSA	20.6	16.2	16.0	24.1	22.6
Rural within MSA (exurbs)	12.2	9.6	8.9	15.9	16.3

NOTE: MSA denotes metropolitan statistical area. To define poverty, the Bureau of the Census uses a set of money income thresholds that vary by family size and composition to determine who is poor. If a family's income is less than the family's threshold, then that family, and every individual in it, is considered poor. The poverty thresholds are updated annually for inflation using the Consumer Price Index (CPI).

SOURCE: U.S. Department of Education, NCES. Common Core of Data (CCD), "Public School District Universe Survey, 1997-98 and U.S. Department of Commerce, Current Population Survey, Small Area Income and Poverty estimates, Title I Eligibility Database, 1997.

Past and Projected Undergraduate Enrollments

Undergraduate enrollment in 4-year institutions is projected to increase faster than enrollment in 2-year institutions in this decade. Women's enrollment is expected to continue increasing faster than men's.

In the past 3 decades, total undergraduate enrollments in degree-granting postsecondary institutions generally increased and are projected to continue doing so throughout this decade. These increases have been accompanied by changes in the enrollment status of students, the type of institution they attend, and the proportion of students who are women. Over this decade, undergraduate enrollment is expected to grow faster at 4-year institutions than at 2-year institutions. Also, the growth rate for full-time undergraduate enrollment is expected to increase faster than part-time enrollment, and women's enrollment, which now exceeds that of men, is projected to grow at a faster rate than men's, reaching a new high in this decade.

UNDERGRADUATE ENROLLMENT: Total undergraduate enrollment in degree-granting 2- and 4-year postsecondary institutions (in thousands), by sex, enrollment status, and type of institution, with projections: Fall 1970–2011

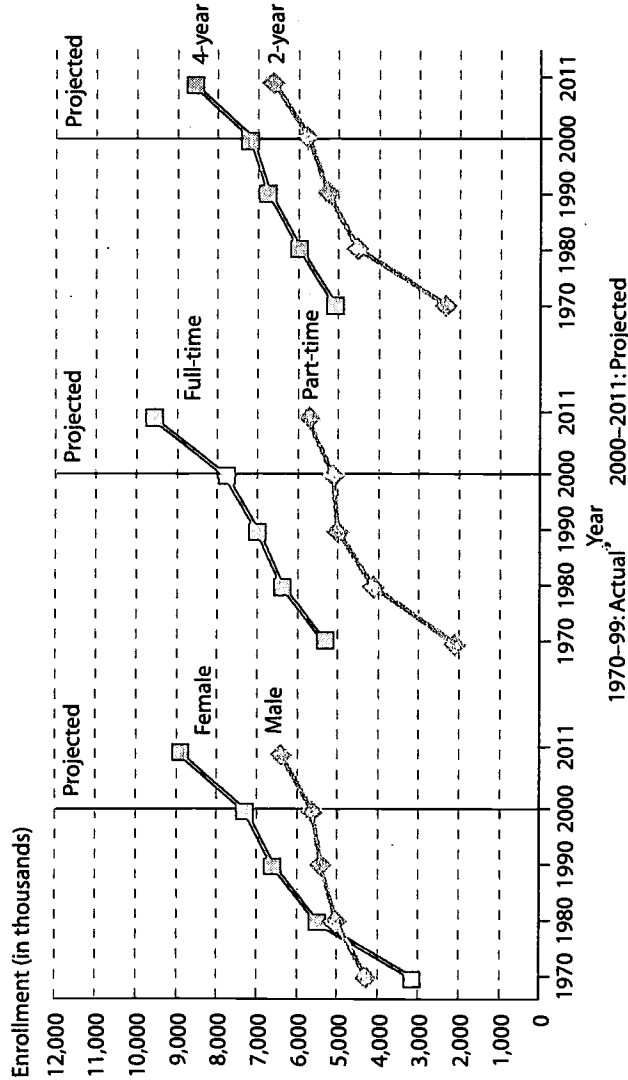

NOTE: Projections are based on the middle alternative assumptions concerning the economy.

SOURCE: U.S. Department of Education, NCES. (2001). *Digest of Education Statistics 2000* (NCES 2001-034), and *Projections of Education Statistics to 2011* (NCES 2001-083).

Mathematics Performance of Students in Grades 4, 8, and 12

The mathematics performance of 4th- and 8th-graders increased steadily from 1990 to 2000, while 12th-graders' performance increased from 1990 to 1996 but then declined between 1996 and 2000.

The National Assessment of Educational Progress (NAEP) has assessed mathematics performance in grades 4, 8, and 12 since 1990. Students in grades 4 and 8 showed steady growth in mathematics achievement from 1990 to 2000. In contrast, 12th-graders in 2000 scored higher than in 1990 but lower than in 1996. Males, on average, scored higher than females in grades 8 and 12 in 2000, but not in grade 4. Of 36 states and other jurisdictions participating in NAEP in 4th grade, 26 had a higher average score and 1 had a lower score in 2000 than in 1992. Of 31 states and other jurisdictions participating in grade 8, 27 had a higher score, and none had a lower score in 2000 than in 1990.

MATHEMATICS PERFORMANCE: Average mathematics scale scores for 4th-, 8th-, and 12th-graders: 1990, 1992, 1996, and 2000

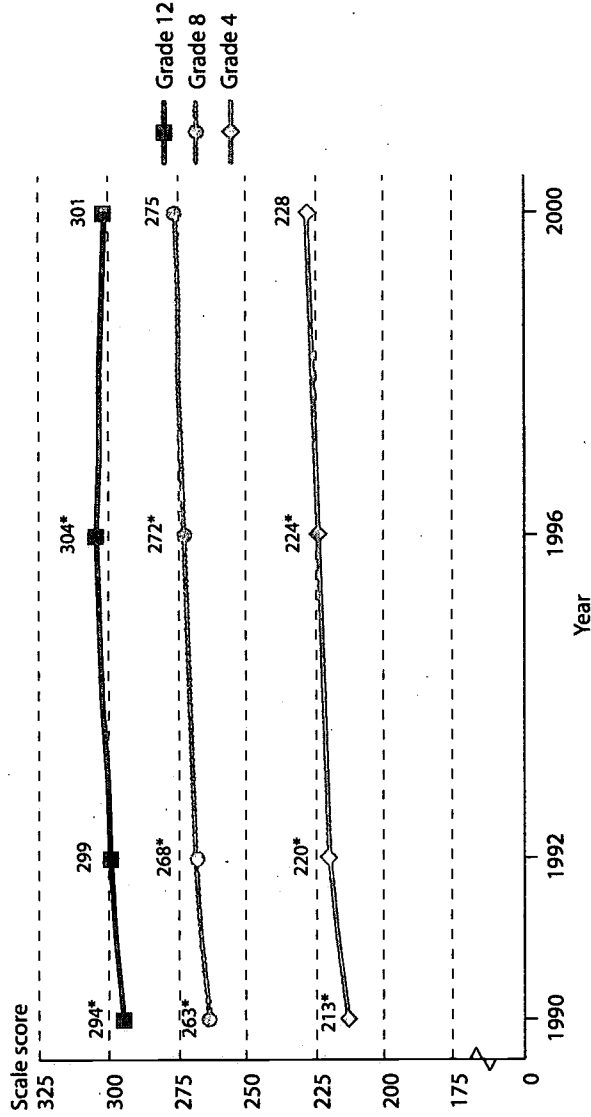

*Significantly different from 2000.

SOURCE: U.S. Department of Education, NCES. (2001). *The Nation's Report Card: Mathematics 2000* (NCES 2001-517).

Compared with students in low-poverty public schools, students in high-poverty public schools have lower achievement scores in 4th-grade mathematics.

Poverty and Student Achievement

In 2000, higher levels of students eligible for free or reduced-price lunch were generally associated with lower scores on the NAEP 4th-grade mathematics assessment. Students in schools with more than 50 percent of students eligible for subsidized lunch had a lower average score than students in schools with a quarter or fewer students eligible. Relative to the total 4th-grade population, there was a lower percentage of White students and a higher percentage of Black and Hispanic students in the highest poverty schools. Also, these schools had higher rates of student absenteeism, a lower percentage of students with a “very positive” attitude toward academic achievement, and less parental involvement than did schools with the least poverty.

POVERTY AND ACHIEVEMENT: Average scale score of all public school students in 4th-grade mathematics, by the percentage of students in the school eligible for free or reduced-price lunch: 2000

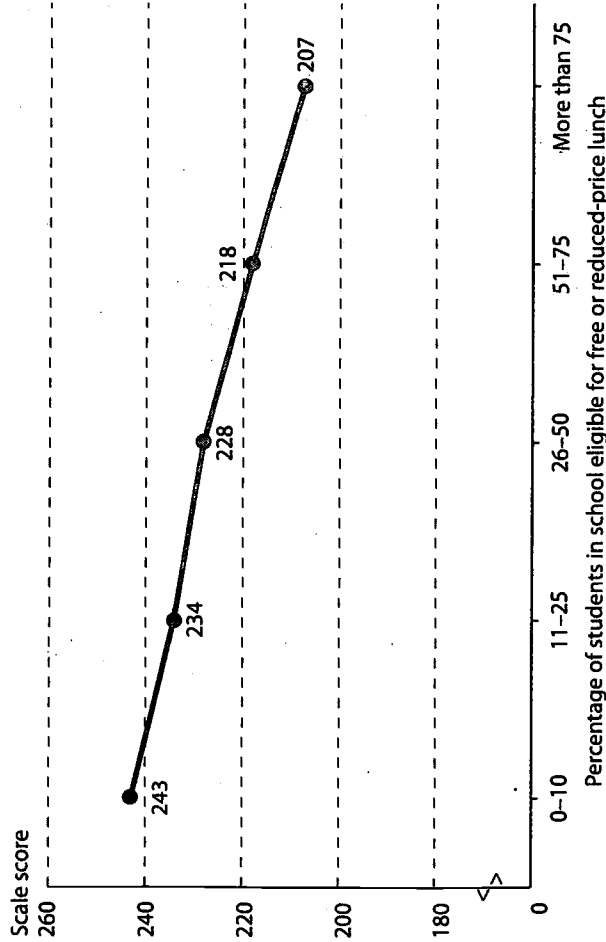

12

SOURCE: U.S. Department of Education, NCES. National Assessment of Educational Progress (NAEP), unpublished data provided by the Educational Testing Service, 2000.

Trends in the Achievement Gap in Reading Between White and Black Students

While White students score higher than Black students in reading, the gaps decreased between the early 1970s and the late 1980s. Since then, the gaps have remained relatively stable or increased.

The National Assessment of Educational Progress (NAEP) has assessed trends in students' reading performance since the early 1970s. NAEP thus provides a picture of how student performance in reading has changed over time, specifically the gap in achievement between Black and White students. The average difference between the reading scores of Black and White students has changed since 1971, with an overall narrowing in the gap, most of which is due to decreases that occurred before 1988. For example, between 1971 and 1988, the Black-White score gap decreased for all 13- and 17-year-olds, while between 1988 and 1999, it increased for 13-year-olds. The apparent increases for 9- and 17-year-olds, however, were not significant.

READING ACHIEVEMENT GAP: Difference in average reading scale scores of 9-, 13-, and 17-year-old White and Black students: 1971-99

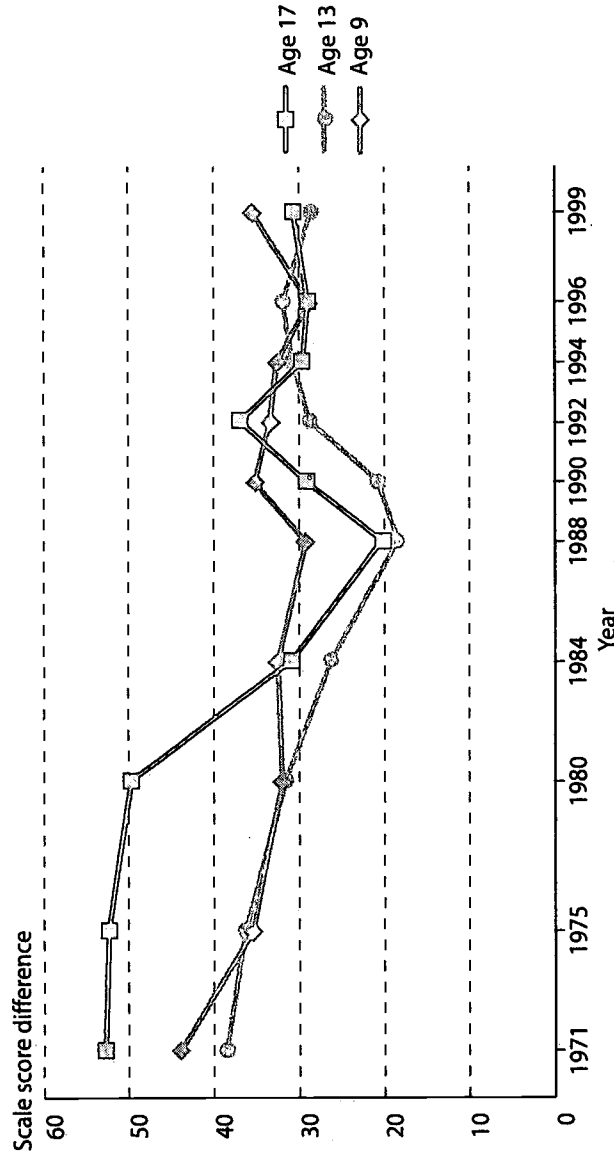

NOTE: The gap is determined by subtracting the average Black score from the average White score at each grade for each year assessed.

SOURCE: U.S. Department of Education, NCES. (2000). NAEP 1999 Trends in Academic Progress: Three Decades of Student Performance (NCES 2000-469) and National Assessment of Educational Progress (NAEP), 1999 Long-Term Trend Assessment, unpublished data produced by the Educational Testing Service.

13

U.S. 15-year-olds performed at the international average in reading literacy in 2000, scored below the average of 3 countries, and above the average of 4 industrialized countries.

The Program for International Student Assessment (PISA) reports on the reading literacy of 15-year-olds in 27 participating Organization for Economic Cooperation and Development (OECD) industrialized countries and 4 non-OECD countries assessed in 2000. The average U.S. reading literacy score was similar to the international average of the 27 OECD countries. U.S. students had a lower average score than students in 3 countries and a higher average score than students in 4 OECD and 3 non-OECD countries. Countries differ in the extent to which students' scores are distributed above and below the national average. Fifteen countries showed less variation from their average score than the United States, no country had more variation, and 15 countries had similar variation.

International Comparisons of Reading Literacy

INTERNATIONAL READING LITERACY: Average reading literacy score of 15-year-olds, by country: 2000

Average score relative to the United States	Country and score					
Significantly higher	Finland	546	Canada	534	New Zealand	529
Not significantly different	Australia	528	Iceland	507	Spain	493
	Ireland	527	France	505	Czech Republic	492
	Korea, Republic of	525	Norway	505	Italy	487
	United Kingdom	523	United States	504	Germany	484
	Japan	522	International average*	500	Liechtenstein	483
	Sweden	516	Denmark	497	Hungary	480
	Austria	507	Switzerland	494	Poland	479
	Belgium	507				
	Greece	474	Latvia	458	Mexico	422
	Portugal	470	Luxembourg	441	Brazil	396
Significantly lower	Russian Federation	462				

*The international average is the average of OECD countries only and thus excludes Brazil, Latvia, Liechtenstein, and the Russian Federation.

NOTE: The variation of students' scores within each country was determined by computing the standard deviation of their combined reading literacy scale scores. In a normal distribution, 68 percent of scores fall within plus or minus one standard deviation of the mean, and 95 percent fall within plus or minus two standard deviations of the mean.

SOURCE: U.S. Department of Education, NCES. (2001). *Outcomes of Learning: Results from the 2000 Program for International Student Assessment of 15-Year-Olds in Reading, Mathematics, and Science Literacy* (NCES 2002-115).

14

12th-Graders' Effort and Interest in School

Over the past 2 decades, 12th-graders' interest in school has declined, while the effort they apply to school has generally shown no measurable change over the past decade.

Seniors' valuation of their learning activities and reports on their efforts do not indicate that higher proportions are more engaged in school or trying harder than previously. Indeed, 12th-graders' interest in school declined from 1983 to 2000. While 40 percent of 1983 seniors said their school work was "often or always meaningful," 28 percent said so in 2000. Similarly, the proportion of seniors who said most of their courses were "quite or very interesting" declined, as did the percentage who said what they were learning will be "quite or very important later in life." In contrast, the proportion who said they "often or always try to do their best work" did not show any measurable change since 1990.

INTEREST IN SCHOOL: Percentage of 12th-graders who expressed various opinions about their school experience: 1983, 1990, 1995, and 2000.

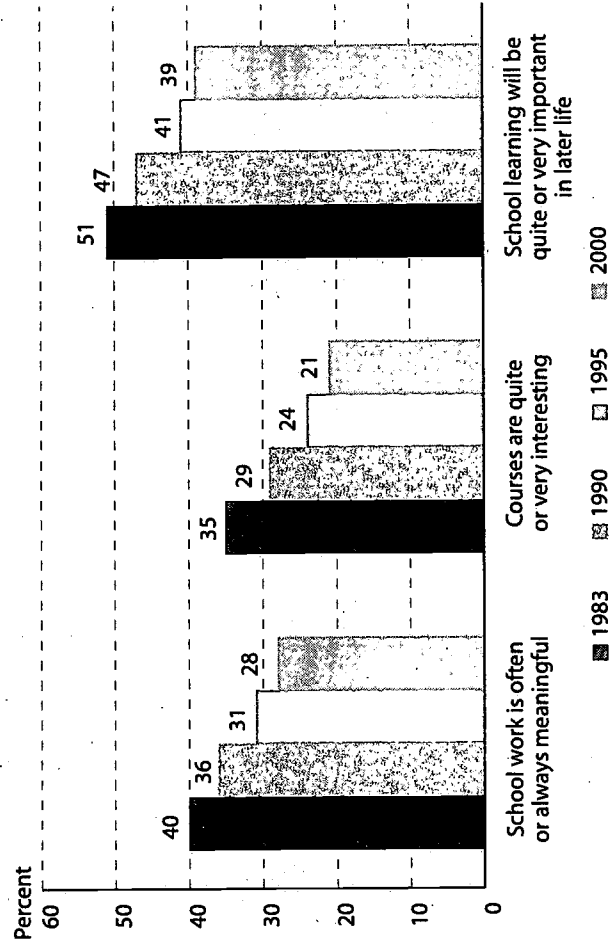

NOTE: The data do not meet NCES standards for response rates.

SOURCE: University of Michigan, Institute for Social Research. Monitoring the Future 12th-Grade Study: 1983, 1990, 1995, and 2000.

Status Dropout Rates, by Race/Ethnicity

Since 1972, the status dropout rates for Whites and Blacks ages 16–24 have declined; the rates for Hispanics have not declined and remain higher than those for other racial/ethnic groups.

The status dropout rate represents the percentage of an age group not enrolled in school and without a high school diploma, GED, or other completion certificate. According to this measure, 11 percent of 16- to 24-year-olds were out of school without a high school credential in 2000. Although the status dropout rate remained fairly consistent from 1992 to 2000, it declined for young adults overall between the early 1970s and 2000; the rate of decline, however, varied for Whites and Blacks. Between 1972 and 2000, the White rate was lower each year than the Black or Hispanic rate, and the White and Black rates declined by nearly 40 percent each, while the Hispanic rate remained fairly constant.

STATUS DROPOUTS: Dropout rates of 16- to 24-year-olds, by race/ethnicity: October 1972–2000

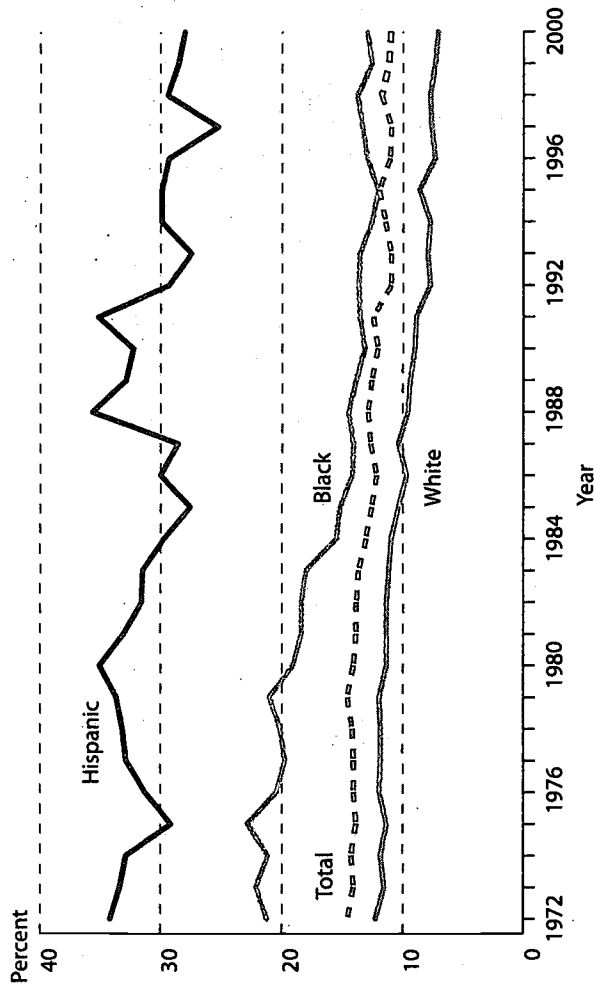

NOTE: Due to relatively small sample sizes, American Indians/Alaska Natives and Asians/Pacific Islanders are included in the total but are not shown separately. In addition, the erratic nature of the Hispanic status rates reflects, in part, the small sample size of Hispanics. Data have been reported separately for Asian/Pacific Islanders since 1998. In 2000, they had a dropout rate of 4 percent (U.S. Department of Education, NCES. [2001]. *Dropout Rates in the United States: 2000* [NCES 2002–114]).

SOURCE: U.S. Department of Commerce, Bureau of the Census. October Current Population Surveys, 1972–2000.

Immediate Transition to College

Immediate college enrollment upon completing high school has increased since 1972, but the gap in immediate enrollment between Whites and Hispanics has widened during the past 2 decades.

The percentage of high school completers who immediately enroll in college reflects the accessibility of higher education and the value they place on college. Paralleling the immediate enrollment rates of high school completers overall, the rates for Whites increased between 1972 and 2000. For blacks, the rates remained fairly constant between 1972 and 1978, decreased between 1978 and 1982, and increased between 1983 and 2000. Since 1983, rates for Blacks have increased faster than those for Whites, reducing the gap between the two groups. For Hispanics, the rates remained relatively constant between 1972 and 2000. Thus, while White rates rose during the 1980s and 1990s, stagnant Hispanic rates resulted in a widening of the Hispanic-White gap.

COLLEGE ENROLLMENT RATES: Immediate enrollment in postsecondary education, by race/ethnicity: October 1972–2000

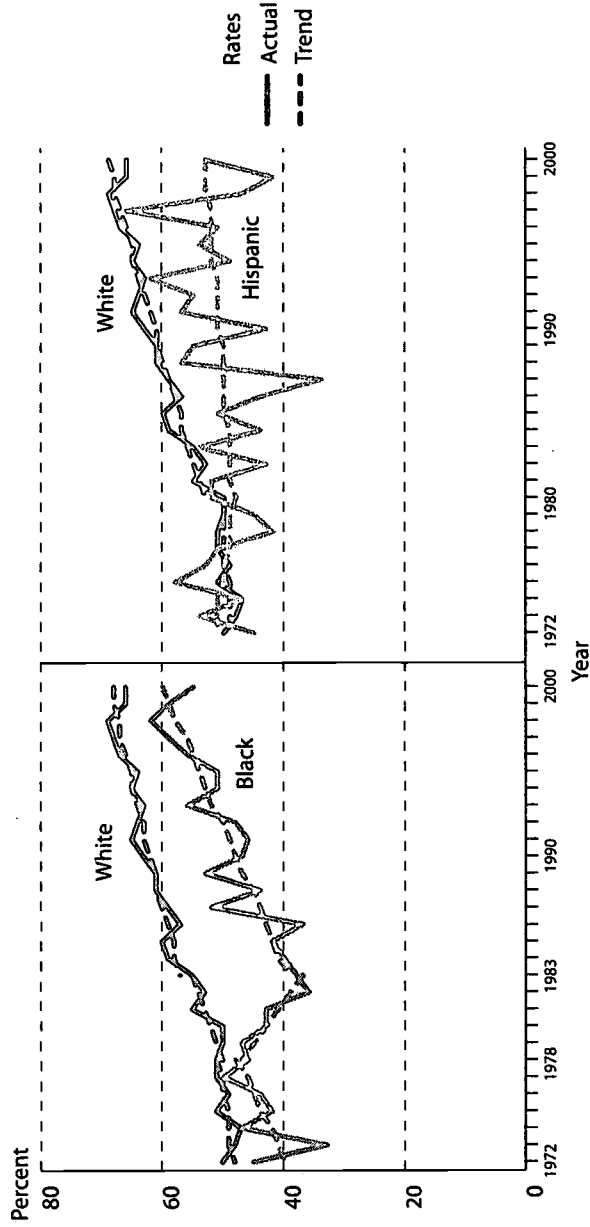

NOTE: Includes those ages 16–24 completing high school in a given year. Actual values are 1-year averages calculated from the Current Population Survey (CPS). The trend values show the linear trend of these average values over the time periods shown. In 1994, the survey instrument for the CPS was changed and weights were adjusted.

SOURCE: U.S. Department of Commerce, Bureau of the Census. October Current Population Surveys, 1972–2000.

Rigorous academic preparation in high school narrows the gap in postsecondary persistence between first-generation students and their peers with a parent who has a bachelor's degree.

Parents' level of education is associated with students' persistence in postsecondary education, but rigorous academic preparation in high school narrows the persistence gap between first-generation and other students. Among postsecondary students who had taken no more than the Core curriculum in high school and enrolled in a 4-year institution in 1995-96, first-generation students were less likely to stay on the persistence track toward a bachelor's degree in 1998 than their counterparts with a parent who has a bachelor's degree (55 versus 69 percent). In contrast, among students who had taken rigorous coursework in high school, no measurable difference was detected between first-generation and other students (81 versus 89 percent).

High School Academic Preparation and Postsecondary Progress

PERSISTENCE TRACK: Percentage of 1995-96 beginning postsecondary students who persisted toward a bachelor's degree, by the academic rigor of their secondary school curriculum and first-generation status: June 1998

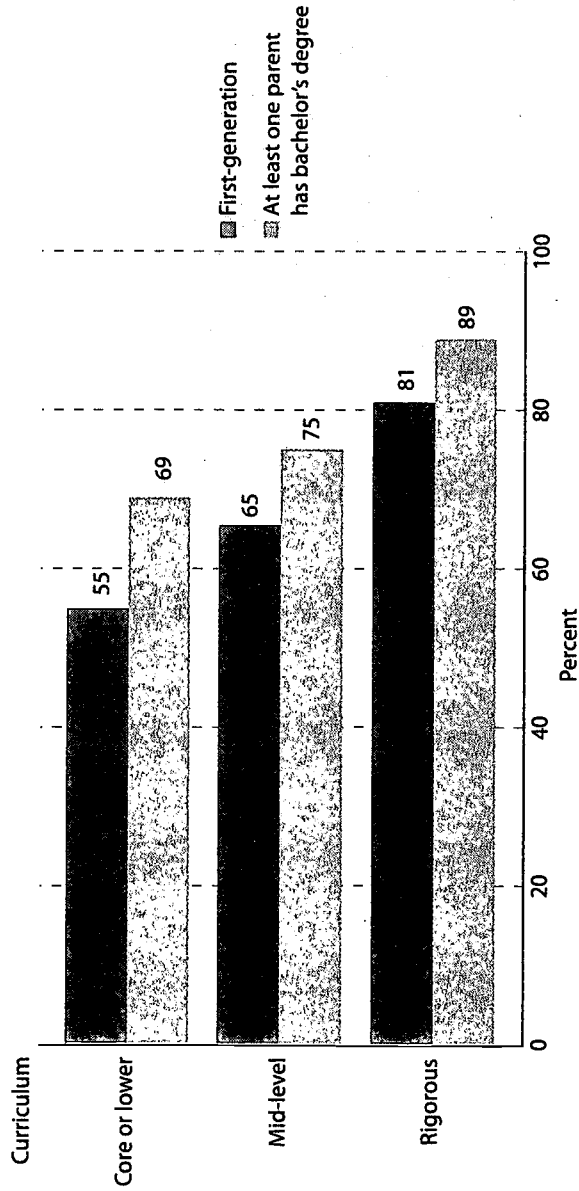

NOTE: First-generation students are those whose parents have no postsecondary education. The Core curriculum includes 4 years of English and 3 years each of mathematics, science, and social science. The "rigorous" curriculum includes at least 4 years of English and mathematics (including precalculus), 3 years each of science (including biology, chemistry, and physics) and social studies, 3 years of foreign language, and 1 honors/AP course or AP test score. Students who stay on the persistence track either remain at the initial 4-year institution in which they enroll or make a lateral transfer to a new 4-year institution with no break in enrollment.

SOURCE: U.S. Department of Education, NCES. Beginning Postsecondary Students Longitudinal Study, "First Follow-up" (BPS:1996/1998).

Trends in Science and Mathematics Course-taking

The percentage of high school graduates who completed advanced coursework in science and mathematics increased between 1982 and 1998.

Since the 1980s, the percentage of high school graduates completing some advanced coursework in science and mathematics has increased. In 1982, 35 percent of graduates had completed advanced science courses; by 1998, 62 percent had done so. Between 1982 and 1998, the percentage completing chemistry I or physics I doubled (from 15 to 30 percent), and the percentage completing chemistry I and physics I increased from 6 to 16 percent. During this period, the percentage of graduates completing courses in advanced academic mathematics also increased (from 26 to 41 percent). Moreover, the percentage completing advanced level II tripled (from 5 to 15 percent), while the percentage completing advanced level III doubled (from 6 to 12 percent).

COURSE-TAKING LEVELS: Percentage of high school graduates who completed middle or advanced level science and mathematics courses, by level of highest course completed: Selected years 1982 to 1998

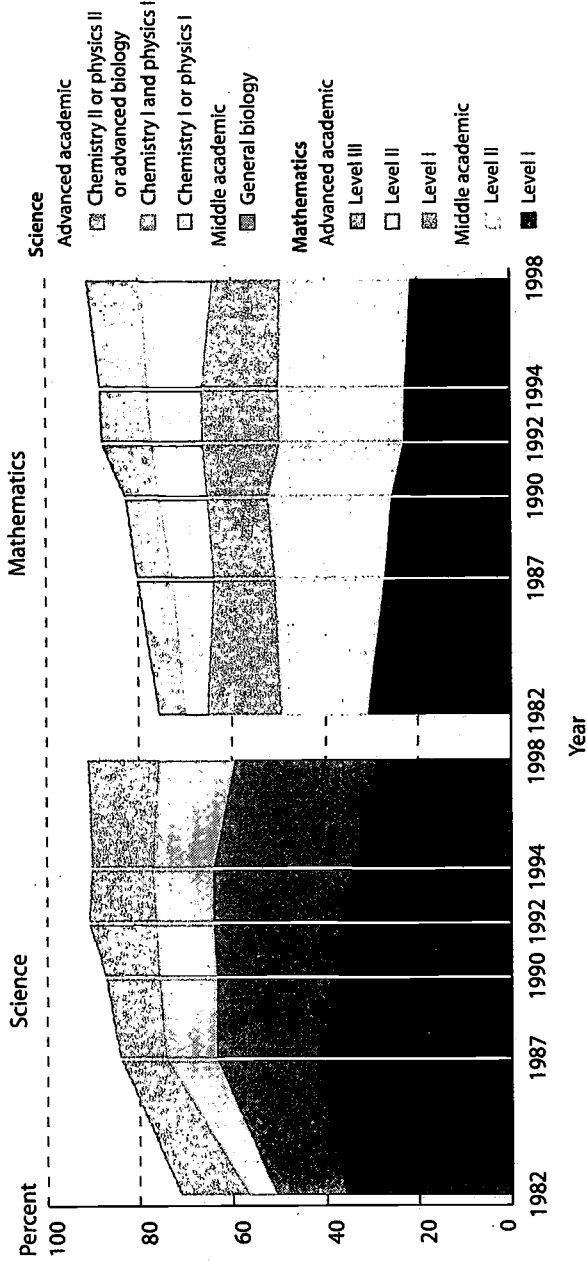

SOURCE: U.S. Department of Education, NCES. High School and Beyond Longitudinal Study of 1980 Sophomores, "First Follow-up" (HS&B:1980/1982); National Education Longitudinal Study of 1988, "High School Transcript Study" (NELS:1988/1992); and National Assessment of Education Progress (NAEP) High School Transcript Studies, 1987, 1990, 1994, and 1998.

Inclusion rates for students of almost all disability types have increased over the past decade.

Since 1975, Congress has required that students with disabilities receive an education in the “least restrictive environment.”* Data suggest that, since 1988, U.S. schools have found the regular education classroom to be the “least restrictive environment” for increasing numbers of students with disabilities. In 1988–99, states reported that 47 percent of students with disabilities spent 80 percent or more of the day in a regular education classroom, while in 1988–89, only 31 percent did so. The increase in the percentage of students with disabilities included in regular classrooms is noteworthy because the number of such students has been growing faster than total school enrollments. The size of the increase varied by type of disability.

SPECIAL EDUCATION: Percentage distribution of students ages 6–21 with disabilities, by educational environment: 1988–89 and 1988–99

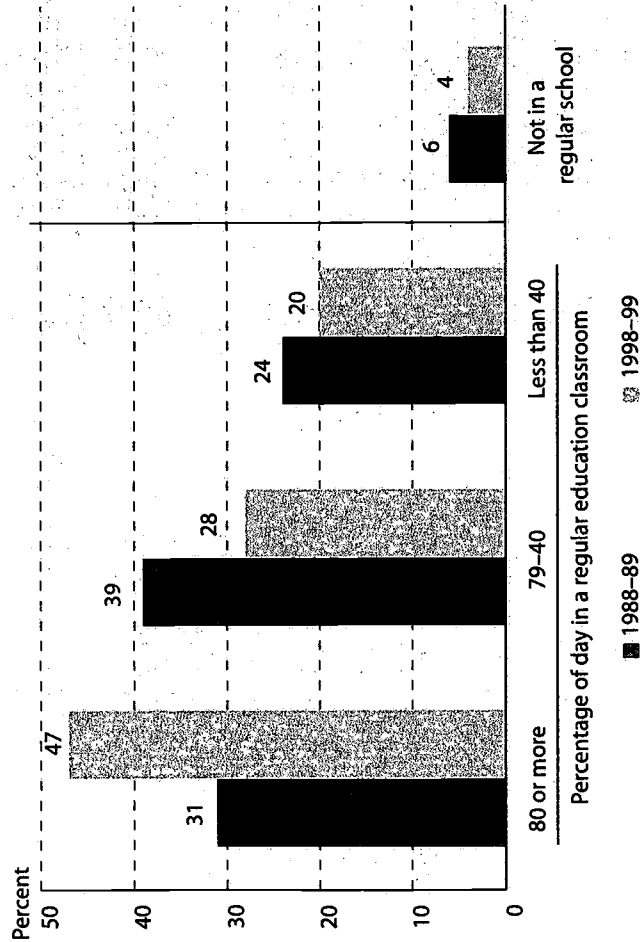

*Congress first required that students with disabilities receive an education in the “least restrictive environment” in the Education of All Handicapped Children Act of 1975 (PL 94-142). This requirement is still in effect under section 612(a)(5) of the Individuals with Disabilities Education Act (IDEA) Amendments of 1997 (PL 105-17).

NOTE: Students counted as disabled are those students served under Part B of the IDEA in the United States and outlying areas. Percentages may not add to 100 due to rounding.

SOURCE: U.S. Department of Education, Office of Special Education and Rehabilitative Services. (2000). *22nd Annual Report to Congress on the Implementation of the Individuals with Disabilities Education Act*, and U.S. Department of Education, Office of Special Education and Rehabilitative Services. (2001). *23rd Annual Report to Congress on the Implementation of the Individuals with Disabilities Education Act*.

20

20

Parental Choice of Schools

The proportion of children enrolled in chosen public schools and in private, not church-related schools increased between 1993 and 1999.

Although public school choice programs* are not available everywhere, the percentage of school districts that allow parents to send their children to a public school other than their assigned school (i.e., to a "chosen school") increased between 1993 and 1999. This increase may explain the fact that the percentage of 1st- through 12th- graders whose parents sent them to their assigned public school declined from 80 to 76 percent over these years. Most of this decline can be attributed to parents enrolling their children in chosen public schools. The percentage of children enrolled in chosen public schools increased from 11 to 14 percent during this period, whereas the percentage enrolled at private, not church-related schools increased from 1.6 to 2.3 percent.

DIFFERENCES IN PARENTAL CHOICE: Percentage distribution of students in grades 1–12, by school type: 1993 and 1999

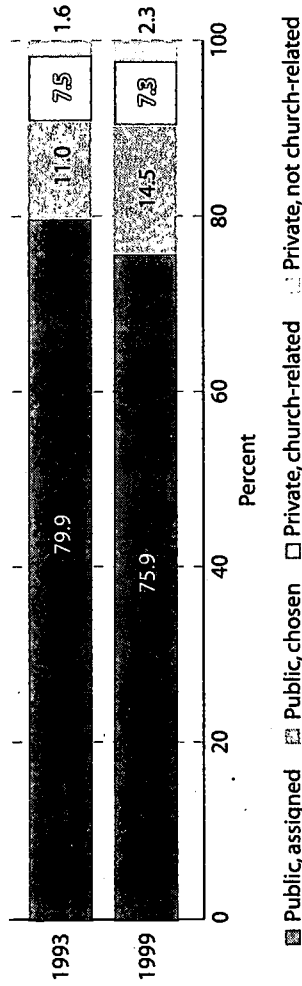

*Public school choice programs "allow public school students to enroll in another school or district outside their attendance area without justification based on special needs" (U.S. Department of Education, NCES. [1998]. *Public School Districts in the United States: A Statistical Profile: 1987–88 to 1993–94* [NCES 98–203]). These programs can include within-district or out-of-district school choice options (which can include charter schools and magnet schools).

NOTE: Excludes students who are home schooled and not enrolled in a public or private school for 9 hours or more per week. These students account for 1.7 percent of the population of school-aged children (U.S. Department of Education, NCES, [forthcoming]. *Trends in the Use of School Choice* [NCES 2002–039]). Percentages may not add to 100.0 due to rounding.

SOURCE: U.S. Department of Education, NCES. National Household Education Surveys Program (NHES); "School Readiness" survey, 1993; "School Safety and Discipline" survey, 1993; "Parent and Family Involvement" survey, 1996; and "Parent Interview" survey, 1999.

College students with low college entrance examination scores are more likely than students with high scores to prepare to become teachers, enter teaching, and remain in the profession.

College graduates who were in the bottom quartile of SAT or ACT scores were more likely than those in the top quartile to have taught before 1997 (14 versus 10 percent) and about twice as likely to predict they would be teaching full time by 2000 (10 versus 4 percent). They were also more likely to have majored in education (15 versus 7 percent) and have prepared to teach,* regardless of whether they actually taught (12 versus 6 percent) or not (6 versus 3 percent). Among graduates who taught, those who scored in the bottom quartile were more likely than those in the top quartile to still be teaching in 1997 (84 versus 68 percent).

Academic Background of College Graduates Who Enter and Leave Teaching

ACADEMIC CALIBER: Percentage distribution of all 1992–93 college graduates and those who became teachers, in the top and bottom quartile of SAT or ACT scores

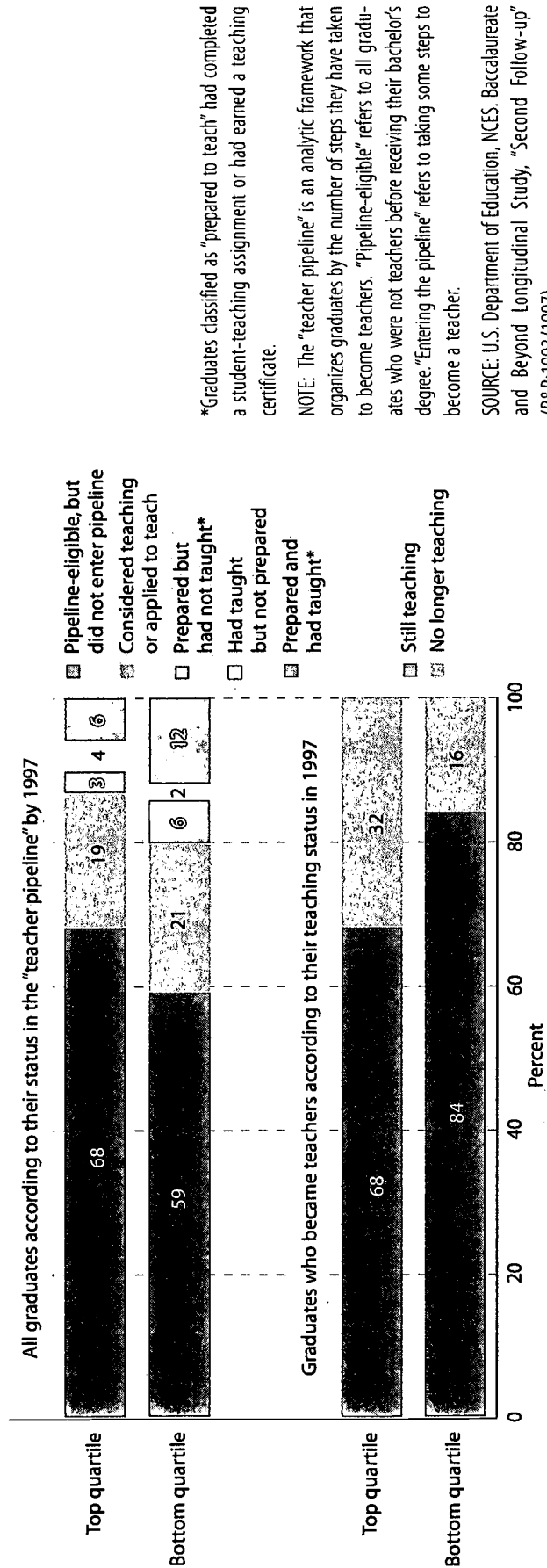

*Graduates classified as "prepared to teach" had completed a student-teaching assignment or had earned a teaching certificate.
 NOTE: The "teacher pipeline" is an analytic framework that organizes graduates by the number of steps they have taken to become teachers. "Pipeline-eligible" refers to all graduates who were not teachers before receiving their bachelor's degree. "Entering the pipeline" refers to taking some steps to become a teacher.

SOURCE: U.S. Department of Education, NCES. Baccalaureate and Beyond Longitudinal Study, "Second Follow-up" (B&B:1993/1997).

Perceived Impact of Work on Postsecondary Learning

Undergraduates who work but identify themselves primarily as students are more likely to report that working negatively affects their academic performance as the hours worked per week increases.

As the number of hours worked per week increased for those who identified themselves primarily as students, so did their likelihood of indicating that work negatively affected their academic performance and limited their number of classes, class schedule, access to the library, and class choice. Among students working to pay for school expenses, 16 percent of those working 1–15 hours per week in 1999–2000 indicated that working had a negative effect on their grades, as did 30 percent who worked 16–20 hours and nearly half who worked 35 or more hours. Of those who were primarily students, the percentage borrowing to pay for school decreased as the hours worked per week increased.

EFFECTS OF WORKING: Among undergraduates who considered themselves primarily students but worked to help pay for school expenses, the percentage reporting various effects of work on their schooling and the percentage who borrowed, by average hours worked per week: 1999–2000

Hours worked per week	Effects of working					
	Limited number of classes	Limited class schedule	Limited class access to library	Reduced choice	Negative effect on grades	Borrowed to pay for education
Total	38.6	46.1	30.1	32.9	34.6	39.4
1–15	14.5	19.6	12.2	12.1	16.2	48.8
16–20	29.0	37.4	23.3	25.6	30.2	41.3
21–34	41.3	50.7	32.4	35.7	39.9	37.8
35 or more	63.3	70.0	47.9	53.0	47.9	31.7

NOTE: Includes students at 4- and less-than-4-year institutions.

SOURCE: U.S. Department of Education, NCES. National Postsecondary Student Aid Study (NPSAS:2000).

Despite the proliferation of distance education offerings, fewer than one in 10 undergraduates enroll in these classes.

Despite the rapid increase in enrollments, course offerings, and the availability of distance education during the 1990s, 8 percent of undergraduates enrolled in such classes at postsecondary institutions in 1999–2000. A higher percentage of students at public 2-year colleges than at 4-year institutions participated in distance education classes (9 versus 7 percent). Of the undergraduates who participated, more used the Internet (60 percent) than live audio or television (37 percent) or prerecorded audio or television (39 percent). Finally, of the undergraduates who enrolled in these offerings, a higher proportion were less satisfied than more satisfied with the quality of instruction they received in their distance education classes compared with their regular classes.

DISTANCE EDUCATION PARTICIPATION: Percentage of undergraduates who participated in distance education classes at postsecondary institutions, and percentage of participants with various experiences with distance education: 1999–2000

Distance education characteristics	4-year			
	Total	2-year public	Public	Private not-for-profit
Total percentage participating ¹	7.6	9.0	6.9	6.1
Percentage of participants ²				
Type of distance education ³				
Live TV/audio	37.3	39.3	36.6	27.5
Prerecorded audio/TV	39.3	43.8	31.5	37.7
Internet	60.1	56.4	61.6	71.5
Entire program available through distance education	29.0	28.8	27.1	29.8
Level of satisfaction with distance education classes compared with regular classes				
Total	100.0	100.0	100.0	100.0
More satisfied	22.6	24.0	20.2	19.1
Equally satisfied	47.1	45.1	51.1	51.6
Less satisfied	29.6	30.0	28.2	28.1

24

¹Denominator is total undergraduate population.

²The denominator in the rows below is the number of undergraduate students who participated in distance education classes.

³Type of distance education categories are not mutually exclusive.

NOTE: Includes students who participated in distance education at either the institution at which they were enrolled or both the institution at which they were enrolled and another institution. Students who participated in distance education only at an institution other than the one at which they were primarily enrolled were excluded. Percentages may not add to 100.0 due to rounding.

SOURCE: U.S. Department of Education, NCES. National Postsecondary Student Aid Study (NPSAS:2000).

24

Status of Women and Minority Faculty

During the 1990s, women advanced their faculty status, including salary. At the end of the decade, however, a gap in salary between male and female faculty remained.

Between 1992 and 1998, full-time female faculty increased their representation in public doctoral, research, and medical institutions. Also, greater percentages of full-time female faculty held the rank of full professor and a doctoral or first-professional degree in 1998 than in 1992. The average base salary for full-time female faculty increased from \$45,580 in 1992 (in constant 1998 dollars) to \$48,370 in 1998, while the salary of their male counterparts remained about the same. Despite the improvement for females, a salary gap remains: full-time male faculty earned about \$13,000 more than their female colleagues in 1998. Even after controlling for characteristics associated with higher pay, full-time female faculty would have earned about \$5,000 less than men.

STATUS OF WOMEN AND MINORITY FACULTY: Percentage of full-time instructional faculty and staff having selected characteristics and their average base salary (in constant 1998 dollars), by sex and race/ethnicity: Fall 1992 and 1998

Faculty characteristics	Percentage of all full-time instructional faculty and staff who:						Average base salary of full-time instructional faculty and staff			
	Taught at public doctoral, research, and medical institutions		Ranked as a full professor		Had a tenure		Had a doctorate or first-professional degree			
	1992	1998	1992	1998	1992	1998	1992	1998		
Total	31.9	34.9	30.4	30.7	54.2	53.1	65.1	67.0	\$56,240	\$56,850
Sex										
Male	35.5	38.0	37.9	38.2	61.3	59.7	72.9	74.2	61,540	61,680
Female	24.7	29.4	15.2	17.6	39.7	41.6	49.6	54.3	45,580	48,370
Race/ethnicity*										
White	32.1	34.8	31.5	32.2	55.6	54.3	65.2	66.6	56,450	57,000
Black	20.3	23.2	19.6	17.5	43.5	43.9	53.2	57.5	48,410	50,360
Asian/Pacific Islander	40.6	46.8	28.1	25.9	47.1	49.1	79.3	84.5	62,770	62,800
Hispanic	32.3	34.8	21.7	25.3	44.9	48.5	63.2	64.0	50,120	54,370
American Indian/ Alaska Native	21.7	34.2	16.1	17.8	43.0	29.4	48.1	53.2	63,990	48,090

*In 1992, respondents did not have the option of selecting more than one racial category, while in 1998 they did.

NOTE: The analysis includes only full-time instructional faculty and staff at Title IV degree-granting institutions who had some instructional duties for credit. Instructional duties include teaching one or more classes for credit or advising or supervising students' academic activities. Base salary estimates for faculty in 1992 were adjusted to constant 1998 dollars using the Consumer Price Index.

SOURCE: U.S. Department of Education, NCES, National Study of Postsecondary Faculty (NSOPF:1993 and NSOPF:1999).

25

Public Effort to Fund Education

At the elementary and secondary level, public revenue per student has increased since the mid-1970s. At the postsecondary level, it has fluctuated slightly without showing a consistent increase.

One measure of public support for education is the level of public investment per student. Overall, public revenue per student at the elementary/secondary level has increased between 1950 and 1999, reflecting the generally greater increase in total public revenue in inflation-adjusted dollars for elementary/secondary education than in enrollments. The patterns in public revenue per student for postsecondary education between 1950 and 1996 differ from those for elementary/secondary education. After rising from 1950 to the mid-1970s, public revenue per student has fluctuated within a narrow band (from \$3,200 to \$4,000). The lack of a consistent increase since then has coincided partly with a general increase in private effort, including the tuition and fees charged to students.

PUBLIC FINANCIAL SUPPORT: Indicators of public effort to fund elementary, secondary, and postsecondary education: Selected years 1950–99

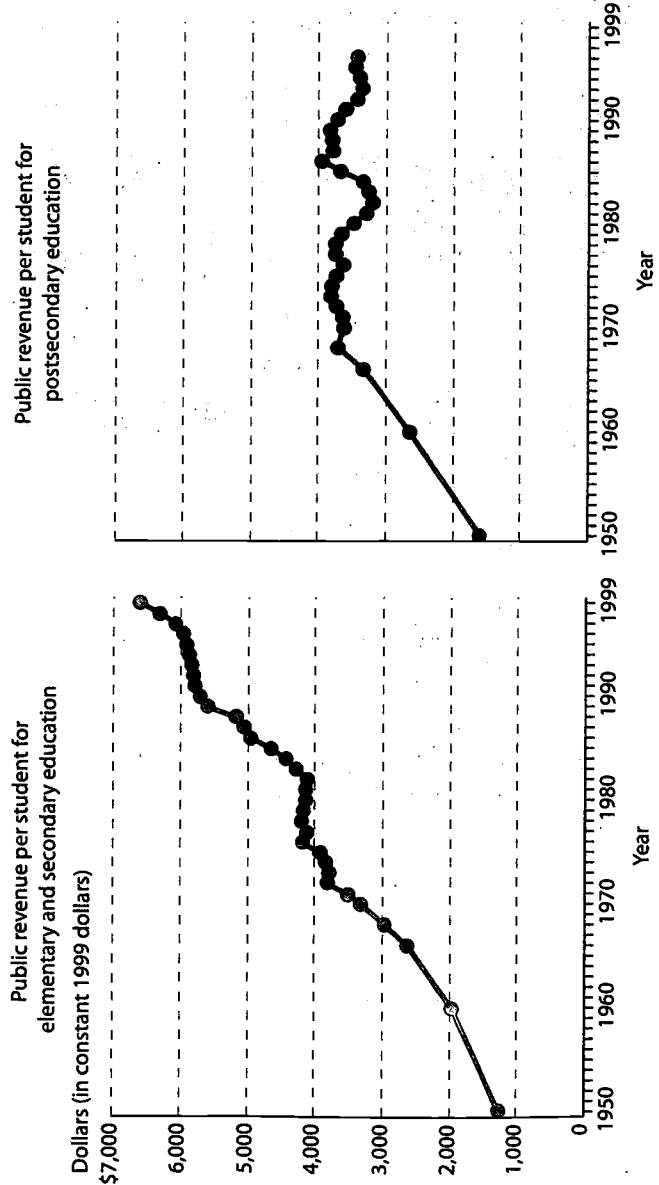

NOTE: Public funds for postsecondary education may be used at many types of institutions, both publicly and privately controlled. Enrollment in both publicly and privately controlled institutions is included. All values for total public revenue for education at both the elementary and secondary and postsecondary levels are in 1999 constant dollars.

SOURCE: U.S. Department of Education, NCES. (2002). *Digest of Education Statistics 2001* (NCES 2002-134); (2001) *Digest of Education Statistics 2000* (NCES 2001-034); (various years: 1964-1997) *Digest of Education Statistics*; (1993) *120 Years of American Education: A Statistical Portrait* (NCES 93-442).

Change in Public School Revenue Sources

Traditional differences in the proportion of local funding to state and federal funding generally persist across the United States, though changes have occurred in the West and Midwest.

Over the years, states have differed in the proportions of state and local funding they receive. The proportion of total revenue that states received from local sources decreased slightly between 1989-90 and 1998-99, while the proportion from federal and state sources increased slightly. During this period, the proportion of revenue from local sources increased in the West, but decreased substantially in the Midwest, where it dropped from 1993-94 to 1994-95 and has not changed since then. This decrease was also accompanied by a large increase in state funding. In the Northeast and South, no shifts were observed. Historic differences, whereby the Northeast relied more on local funding than the South and West, persisted.

CHANGE IN REVENUE SOURCES: Percentage distribution of total revenues for public elementary and secondary schools, by region and revenue source: 1989-90 to 1998-99

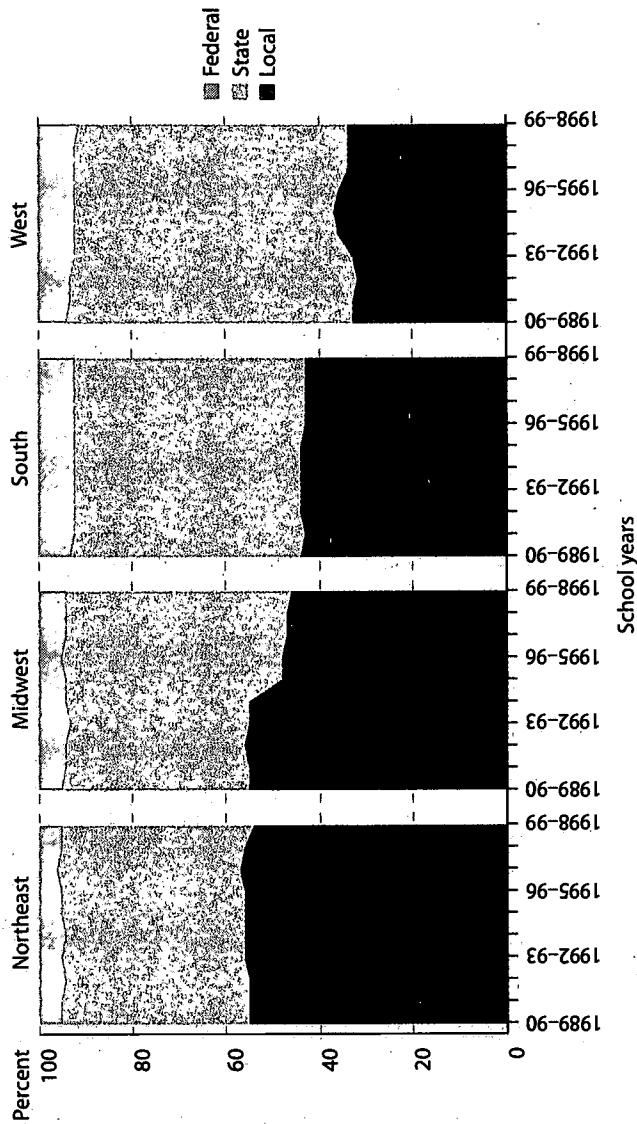

SOURCE: U.S. Department of Education, NCES. Common Core of Data (CCD), National Public Education Financial Survey Data, 1989-90 to 1998-99.

27

27

U.S. expenditures on primary and secondary education rank high compared with those of other countries. U.S. spending on postsecondary education is the highest of all the OECD countries.

Per student expenditures for education are positively related to GDP per capita. In 1998, wealthier countries, on average, spent more per student for primary, secondary, and postsecondary education than did less wealthy countries as measured by GDP per capita. Annual expenditures per student at the primary level among OECD members ranged from \$863 in Mexico to \$6,713 in Denmark, and at the secondary level, from \$1,438 in Poland to \$9,348 in Switzerland. U.S. spending on primary and secondary education ranked high compared with the OECD countries, \$6,043 and \$7,764, respectively. At \$19,802 per student, U.S. postsecondary expenditures were higher than those of any other OECD country and over twice those of 16 OECD countries.

International Comparisons of Expenditures for Education

INTERNATIONAL EXPENDITURES FOR EDUCATION: Educational expenditures per student in relation to GDP per capita, by level of education for selected OECD countries: 1998

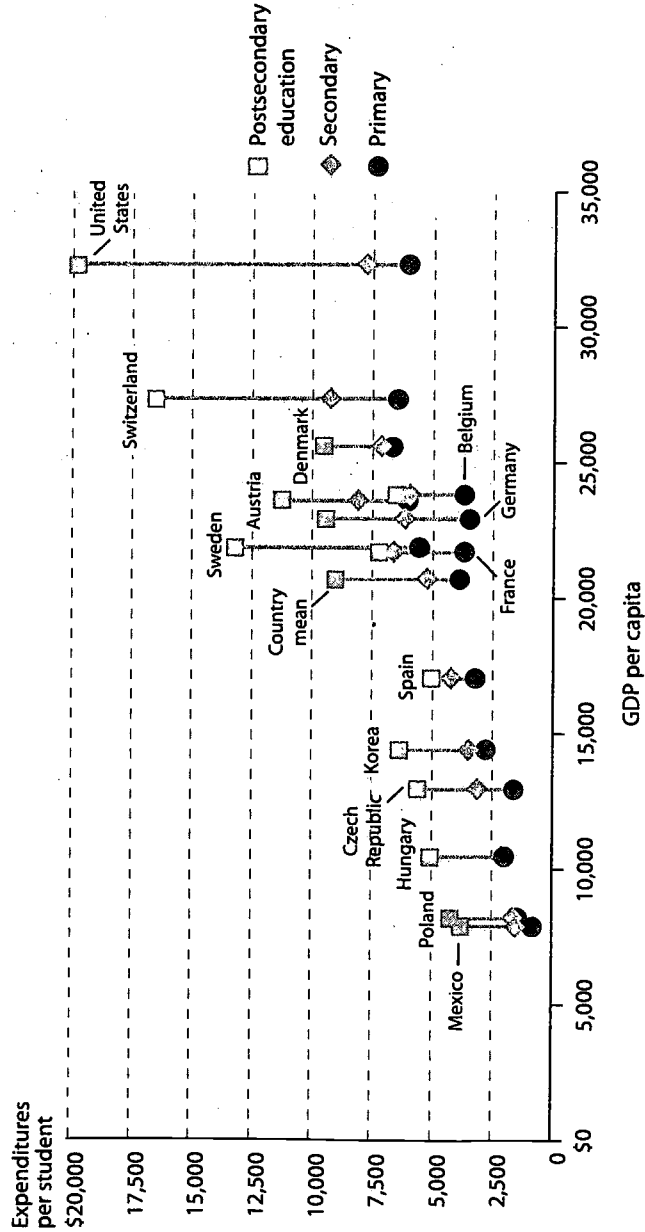

NOTE: Per student expenditures are calculated based on public and private full-time-equivalent (FTE) enrollment figures and expenditures from both public and private sources where data are available. Purchasing Power Parity (PPP) indices are used to convert other currencies to U.S. dollars. Within-country consumer price indices are used to adjust the PPP indices to account for inflation because the fiscal year has a different starting date in different countries.

SOURCE: Organization for Economic Cooperation and Development, Center for Educational Research and Innovation. (2001). *Education at a Glance: OECD Indicators, 2001*.

United States

Department of Education

ED Pubs

8242-B Sandy Court

Jessup, MD 20794-1398

Official Business

Penalty for Private Use, \$300

Postage and Fees Paid
U.S. Department of Education
Permit No. G-17

FIRST-CLASS MAIL

EP:82924
PHILIP PIELE
DIRECTOR ERIC CLEARINGHOUSE ON
5207 UNIVERSITY OF OREGON
EDUCATIONAL MANAGEMENT
1787 AGATE ST
EUGENE OR 97403-1923

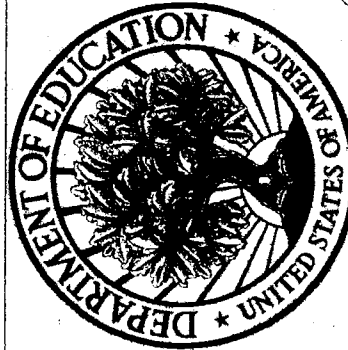

BEST COPY AVAILABLE

29



U.S. Department of Education
Office of Educational Research and Improvement (OERI)
National Library of Education (NLE)
Educational Resources Information Center (ERIC)



NOTICE

Reproduction Basis

- This document is covered by a signed "Reproduction Release (Blanket)" form (on file within the ERIC system), encompassing all or classes of documents from its source organization and, therefore, does not require a "Specific Document" Release form.
- This document is Federally-funded, or carries its own permission to reproduce, or is otherwise in the public domain and, therefore, may be reproduced by ERIC without a signed Reproduction Release form (either "Specific Document" or "Blanket").